

Autonics TEMPERATURE CONTROLLER TC3YF SERIES

M A N U A L



Thank you very much for selecting Autonics products.
For your safety, please read the following before using.

Caution for your safety

- Please keep these instructions and review them before using this unit.
- Please observe the cautions that follow:
- Warning** Serious injury may result if instructions are not followed.
- Caution** Product may be damaged, or injury may result if instructions are not followed.
- The following is an explanation of the symbols used in the operation manual.
- Warning** Injury or danger may occur under special conditions.

Warning

- In case of using this unit with machineries(Nuclear power control, medical equipment, vehicle, train, airplane, combustion apparatus, entertainment or safety device etc), it requires installing fail-safe device, or contact us for information on type required.**
It may result in serious damage, fire or human injury
- It must be mounted on Panel.**
It may give an electric shock.
- Do not connect terminals when it is power on.**
It may give an electric shock.
- Before connecting power, check the terminal number.**
It may cause a fire.
- Do not disassemble and modify this unit, when it requires.**
If needs, please contact us.
It may give an electric shock and cause a fire.

Caution

- This unit shall not be used outdoors.**
It might shorten the life cycle of the product or give an electric shock.
- For wire connection, AWG No. 12-28 should be used and screw bolt on terminal block with 0.3N · m to 0.4N · m strength.**
It may result in malfunction or fire due to contact failure.
- Please observe specification rating.**
It might shorten the life cycle of the product and cause a fire.
- Do not use the load beyond rated switching capacity of Relay contact.**
It may cause insulation failure, contact melt, contact failure, relay broken, fire etc.
- In cleaning the unit, do not use water or an oil-based detergent**
It might cause an electric shock or fire that will result in damage to the product.
- Do not use this unit at place where there are flammable or explosive gas, humidity, direct ray the sun, radiant heat, vibration, impact etc.**
It may cause explosion.
- Do not inflow dust or wire dregs into inside of this unit.**
It may cause a fire or mechanical trouble.
- Before connecting wires, check the terminal polarity.**
It may cause a fire or explosion.

Front panel identification

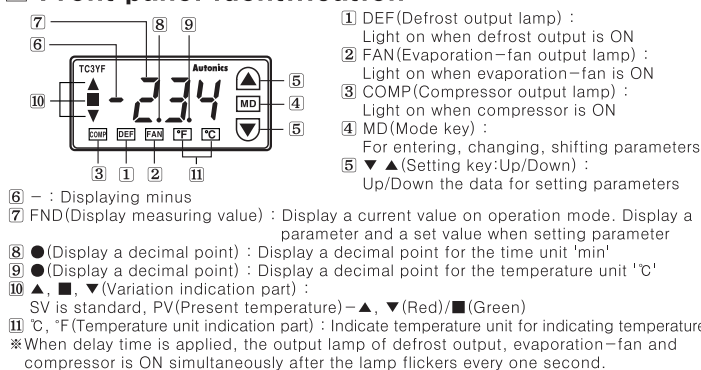

Dimensions

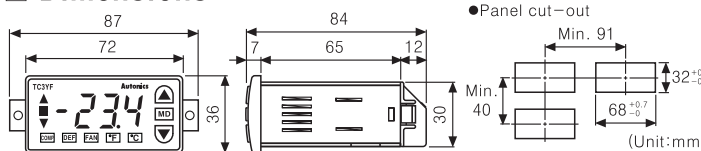

Connections

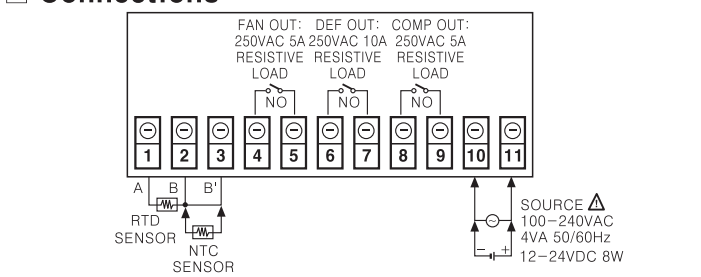

Functions

- Adjustable Hysteresis [HYS]**
 - This product controls compressor output by ON/OFF control type.
 - Frequent ON/OFF output causes noise and chattering. Proper interval on ON/OFF control prevents it and a malfunction on contact and compressor.
 - Ex) Setting value (SV) : -20°C, Hysteresis (HYS) : 1
When current temperature is -19°C, compressor outputs ON.
When current temperature is -21°C, compressor outputs OFF.
- ON/OFF control** is also called 2-position control because of OFF output for low temperature and ON output for high temperature with a target value.
- Input correction [Inb]**
 - This model corrects the error, which is occurred by inputted signal.
 - When measuring a temperature, it corrects the error occurred by disturbance or extended wire.
 - The corrected temperature and set value is compared for the operation.
 - Ex) Current temperature : -18°C, Display value : -20°C
When setting Inb as 2, display value will be -18°C.
- Defrost function**
 - When compressor drives for long time, heat efficiency is lowered because evaporator and refrigerator are frozen. In this case, it is called defrost function for removing ice and frost.
 - Heating defrost method**
After mounting heater around evaporator, operate the heater with defrost period and defrost time setting of controller and remove frost.
 - Manual defrost method**
It operates defrosting for setting defrost time when press ▲ for 3sec during driving the compressor. When pressing ▼ for sec, defrost function is stopped, defrost output is turned to OFF and setting defrost period is restarted from OFF.
After operating defrost for setting defrost time, setting defrost period is restarted.
In case of defrost period is "00", manual defrosting is operated only.
- Relay output**
Relay output is operating for ON/OFF output by using relay contact. It repeats ON/OFF the load in order to heating or cooling operation continuously. In this case, drive magnetic S/W or power relay(big capacity) can be used by using relay contact.
For using relay contact, do not exceed relay capacity.
Otherwise a relay can be damaged and it can cause fire.
When using relay contact to control main relay or magnetic switch, please use surge absorber in order not to inflow of counter electromotive force, caused from the coil of relay and magnet, into the inner body.
Life cycle of relay(electrical/mechanical) is indicated in "Specifications". Please design the system after checking the life cycle of relay.
*The above specifications are subject to change and some models may be discontinued without notice.

Ordering information

TC	3	Y	F	-	□	□	R
①	②	③	④	⑤	⑥	⑦	
①Item	TC	Temperature Controller					
②Digit	3	999(Digit)					
③Size	Y	DIN W72×H36mm					
④Refrigeration control	F	Freezing					
⑤Sub output	1	Compressor					
	2	Compressor+Defrost output					
	3	Compressor+Defrost output+Evaporation-fan output					
⑥Power supply	1	12-24VDC					
	4	100-240VAC 50/60Hz					
⑦Output	R	Relay output					

Specifications

Model(★1)	TC3YF-11R	TC3YF-14R	TC3YF-21R	TC3YF-24R	TC3YF-31R	TC3YF-34R
Power supply	12-24VDC	100-240VAC 50/60Hz	12-24VDC	100-240VAC 50/60Hz	12-24VDC	100-240VAC 50/60Hz
Allowable voltage range	90 to 110% of rated voltage					
Power consumption	8W	4VA	8W	4VA	8W	4VA
Indication method	7segment LED Display(Red)					
Display	NTC : -40.0~99.9°C(40~212°F), RTD : -99.9~99.9°C(-148~212°F)					
Display method	[PV ±0.5% or 1°C Max.] rdg ±1digit(Room temperature : 23 ±5°C)					
Sampling period	Min. 0.5sec					
Input sensor	NTC : Thermistor, RTD : DPT 100Ω(★2)					
Input of line resistance	Tolerance line resistance is max. 5Ω					
Control method	ON/OFF control:Adjustment sensitivity(HYS) variable(0.5~5.0°C, 2~50°F)					
Control output	Compressor (250VAC 5A 1a)	Compressor (250VAC 5A 1a) Defrost output (250VAC 10A 1a)	Compressor(250VAC 5A 1a) Defrost output (250VAC 10A 1a) +Evaporation-fan output (250VAC 5A 1a)			
Insulation resistance	Min. 100MΩ(at 500VDC mega)					
Dielectric strength	2000VAC 60Hz for 1 minute(between external terminal and case)					
Noise strength	±500V R-phase and S-phase(pulse width 1μs)[12-24VDC] ±2kV R-phase and S-phase(pulse width 1μs)[100-240VAC]					
Memory retention	Approx. 10 years(When using non-volatile semiconductor memory type)					
Relay life cycle	COMP	Mechanical : Min.20,000,000 times Electrical : Min.50,000 times(250VAC 5A resistive load)				
	DEF	Mechanical : Min.20,000,000 times Electrical : Min.100,000 times(250VAC 10A resistive load)				
Vibration	Mechanical	0.75mm amplitude at frequency of 10 to 55Hz in each of X, Y, Z directions for 2 hours				
	Malfunction	0.5mm amplitude at frequency of 10 to 55Hz in each of X, Y, Z directions for 10 minutes				
Ambient temperature	-10 ~ 50°C (at non-freezing status)					
Storage temperature	-20 ~ 60°C (at non-freezing status)					
Ambient humidity	35 ~ 85%RH					
Protection	IP65					
Approval	— (★3) — (★3) — (★3) — (★3) — (★3) — (★3)					
Weight	Approx. 143g					

*Indication accuracy of section except for room temperature is ambient temperature range : [The bigger one between PV ±0.5% or 1°C] rdg ±1°C
 *(★1) There is no relay point of contract output where defrost lamp is lighted for 11R/14R.
 *(★2) RTD is optional.
 *(★3) No UL certificate is acquired for this model.

SV checking and setting

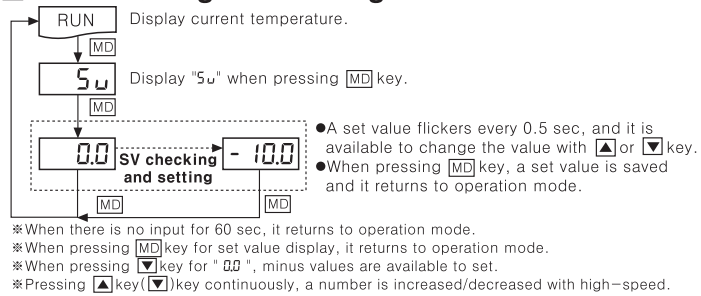

Flow chart for first setting group

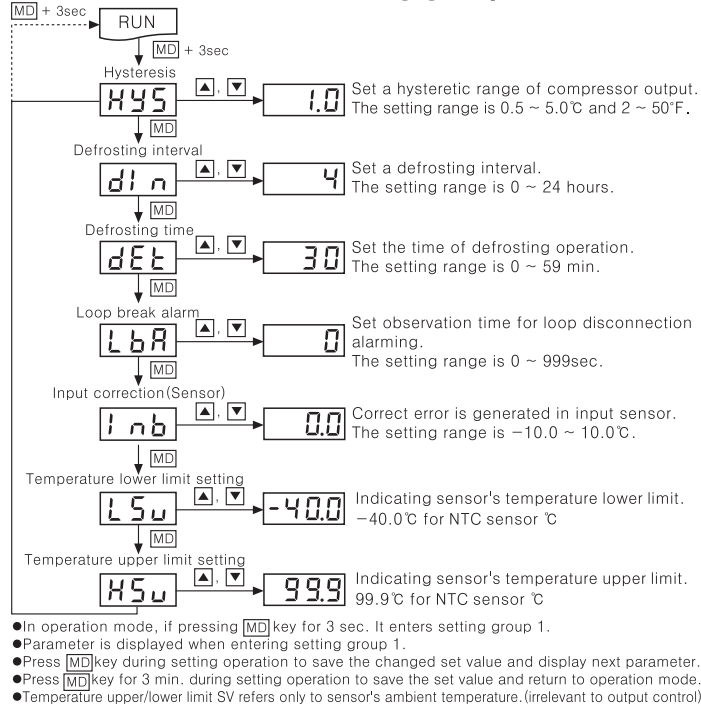

Flow chart for second setting group

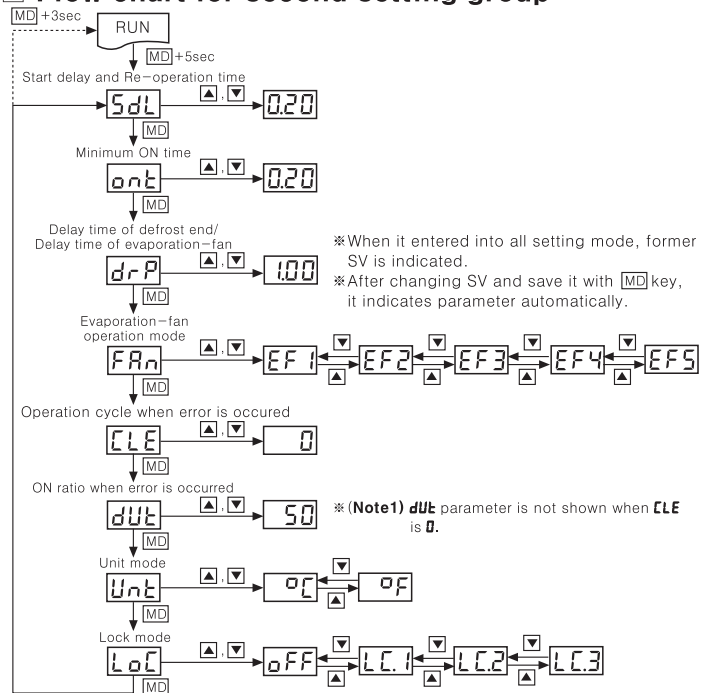

Input specification and range

Input sensor	Using range	
	°C	°F
RTD(DPT 100Ω)	-99.9 ~ 99.9	-148 ~ 212
Thermistor	-40.0 ~ 99.9	-40 ~ 212

*A temperature sensor converts temperature into electric signal, and a temperature controller measures the temperature in order to do ON/OFF the control output.
 *The setting is available within using range, and set range is fixed with using range.

Operation

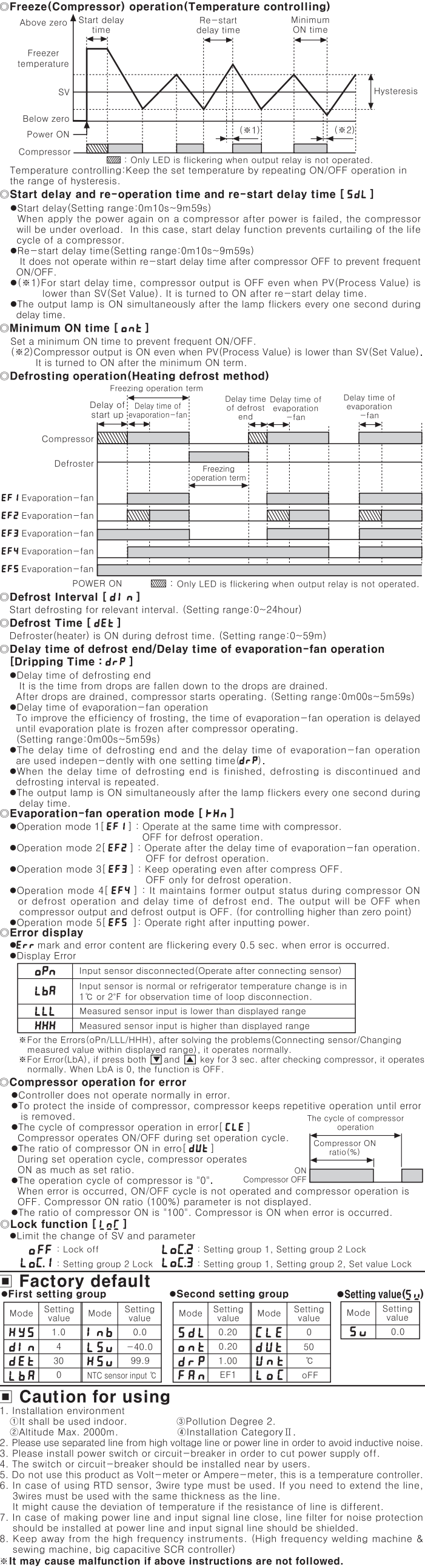

Caution for using

- Installation environment
 - It shall be used indoor.
 - Altitude Max. 2000m.
 - Pollution Degree 2.
 - Installation Category II.
 - Please use separated line from high voltage line or power line in order to avoid inductive noise.
 - Install in place where power switch or circuit-breaker in order to cut power supply off.
 - The switch or circuit-breaker should be installed near by users.
 - Do not use this product as Volt-meter or Ampere-meter, this is a temperature controller.
 - In case of using RTD sensor, 3wire type must be used. If you need to extend the line, 3wires must be used with the same thickness as the line.
 It might cause the deviation of temperature if the resistance of line is different.
 - In case of making power line and input signal line close, line filter for noise protection should be installed at power line and input signal line should be shielded.
 - Keep away from the high frequency instruments. (High frequency welding machine & sewing machine, big capacitive SCR controller)
- *It may cause malfunction if above instructions are not followed.